

SADA MEDICAL

Ethylene Oxide Sterilizer

- Effective at low temperature sterilization
- Material compatibility
- Excellent penetration with no lumen restrictions
- Non-corrosive
- Relatively low capital equipment cost

SD-XH120

SD-XH220



SD-XH

Based on a gas diffusion process, EO is capable of sterilizing and rendering products free of micro-organisms. Sterility occurs when an EO gas molecule reacts with and destroys the bacteria DNA . All products must be placed in breathable packaging that allows gas to penetrate the sterile barrier and reach all surfaces of the device or product.



Efficiency

Utilisation of an intelligent systems and high performance components



Low temperatures

Sterilization at low temperature 36-55°C. Fit for wet heat sensitive material .



Mini printer

Print the sterilization information on thermal paper whole cycle .



Low noise

High performance vacuum Pump the working noise lower 40 db



EO gas

EO gas cartridge, dosing inside machine, safe and convenient for operator



Visible

7" color LCD touch panel. Process clearly display on screen .

Data export

The cycle reports can be automatically saved via the USB driver.



Parametric release

Allows for the release of products directly after processing which results in fast turn .

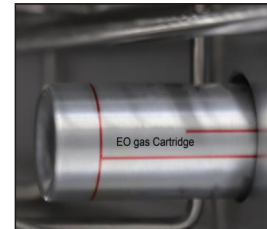
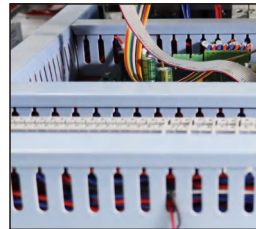

SADA MEDICAL

Ethylene Oxide Sterilizer

Overall Dimension

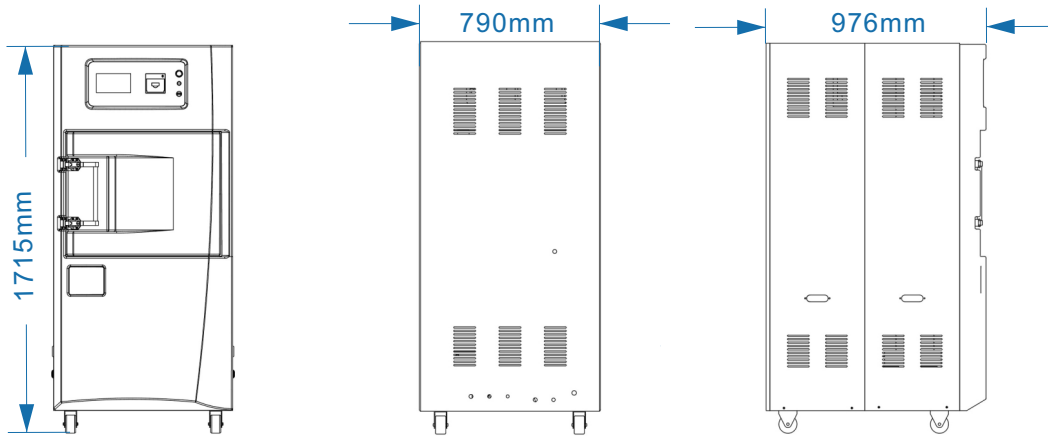

Schematic Diagram Of Partial Outline

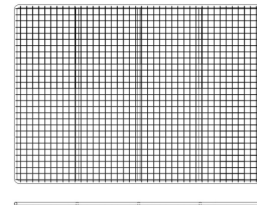
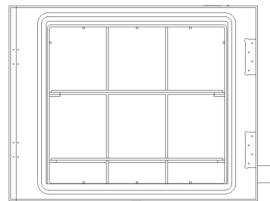
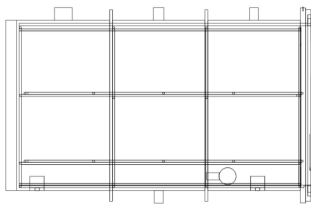

Technical parameters

	SD-XH120	SD-XH220
Voltage	AC220V	AC220V
Power	3KVA	3.6KVA
Cell material	Aluminium alloy	Aluminium alloy
Chamber size	700X450X400mm	820X510X460mm
Volume	120L	220L
Machine size	976X790X1715mm	976X790X1715mm
Net weight	210KG	220KG
Working pressure	-60Kpa	-60Kpa
Cycle time	5-8 hours	5-8 hours
Working temperature	35-60℃	35-60℃
Humidity	RH 45-85%	RH 45-85%
Display screen	7' color LCD	7' color LCD
Data export	USB	USB
Mini printer	Yes	Yes
Gas cartridge	72 g	130 g
Shelves(trays)	2	2



EO Sterilization Supplies

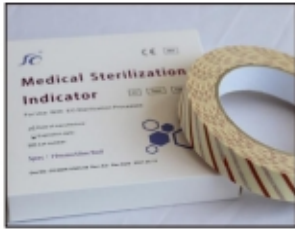

EO indicator tape



EO sterilization pouch



EO indicator strip



EO biological indicator



EO label



Medical sterilization pouch